

MBRD2060 SCHOTTKY RECTIFIER

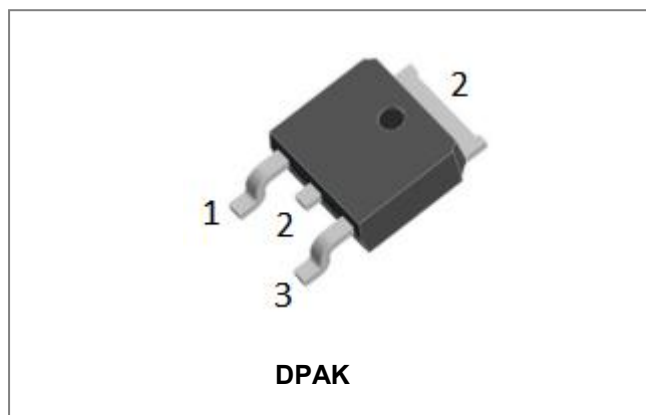

Features

- 150°C T_J operation
- Center tap configuration
- Low forward voltage drop
- High purity, high temperature epoxy encapsulation for enhanced mechanical strength and moisture resistance
- High frequency operation
- Guard ring for enhanced ruggedness and long term reliability
- “-A” is an AEC-Q101 qualified device
- This is a Pb – Free Device
- All SMC parts are traceable to the wafer lot
- Additional testing can be offered upon request

Circuit Diagram

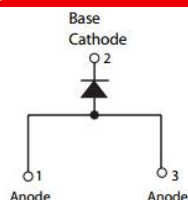

Applications

- Switching power supply
- Converters
- Free-Wheeling diodes
- Reverse battery protection
- Battery charging

Maximum Ratings:

Characteristics	Symbol	Condition	Max.	Units
Peak Repetitive Reverse Voltage Working Peak Reverse Voltage DC Blocking Voltage	V _{RRM} V _{RWM} V _R	-	60	V
Average Rectified Forward Current	I _{F(AV)}	50% duty cycle @T _c =105°C, rectangular wave form	20	A
Peak One Cycle Non-Repetitive Surge Current	I _{FSM}	8.3ms, Half Sine pulse	400	A

Electrical Characteristics:

Characteristics	Symbol	Condition	Typ.	Max.	Units
Forward Voltage Drop*	V _{F1}	@ 20A, Pulse, T _J = 25 °C	0.65	0.75	V
	V _{F2}	@ 20A, Pulse, T _J = 125 °C	0.63	0.65	V
Reverse Current *	I _{R1}	@V _R = rated V _R , T _J = 25 °C	0.1	1.0	mA
	I _{R2}	@V _R = rated V _R , T _J = 125 °C	30	75.0	mA
Junction Capacitance	C _T	@V _R = 5.0V, T _C = 25 °C f _{sig} = 1MHz	400	900	pF

* Pulse width < 300 μs, duty cycle < 2%

Thermal-Mechanical Specifications:

Characteristics	Symbol	Condition	Specification	Units
Junction Temperature	T_J	-	-55 to +150	$^{\circ}\text{C}$
Storage Temperature	T_{stg}	-	-55 to +150	$^{\circ}\text{C}$
Typical Thermal Resistance Junction to Case	$R_{\theta\text{JC}}$	-	1.5	$^{\circ}\text{C/W}$
Approximate Weight	wt	-	0.39	g
Case Style	DPAK			

Ratings and Characteristics Curves

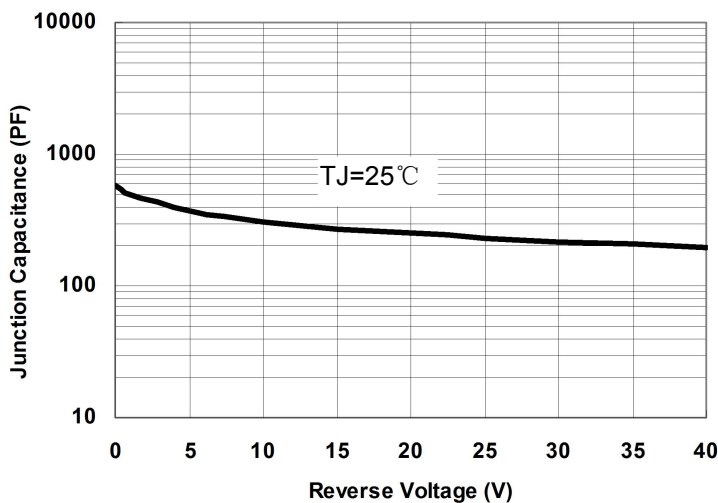

Fig.1-Typical Junction Capacitance

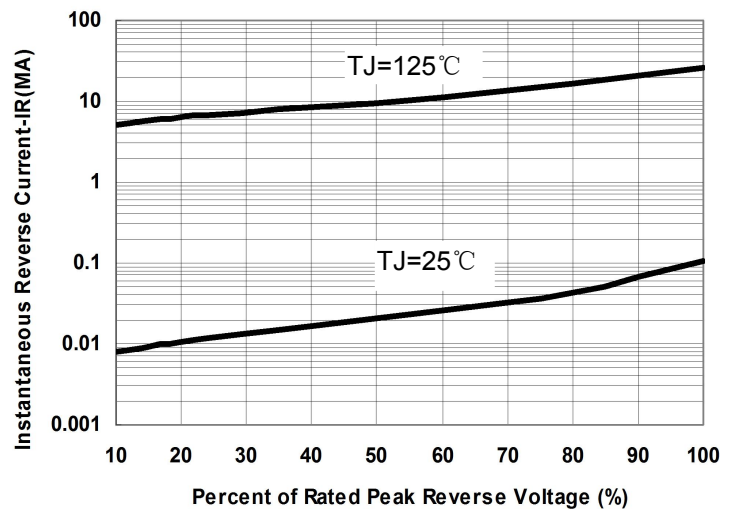

Fig.2-Typical Reverse Characteristics

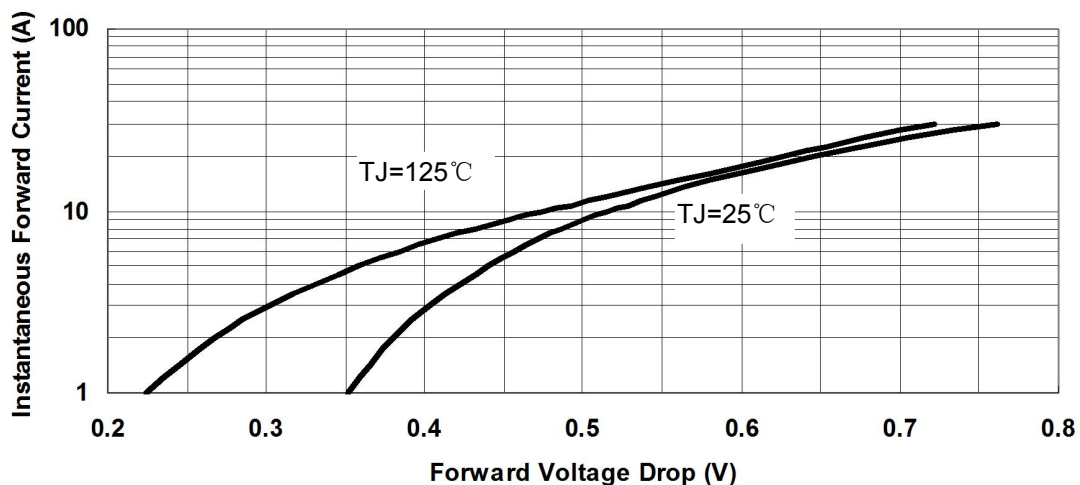
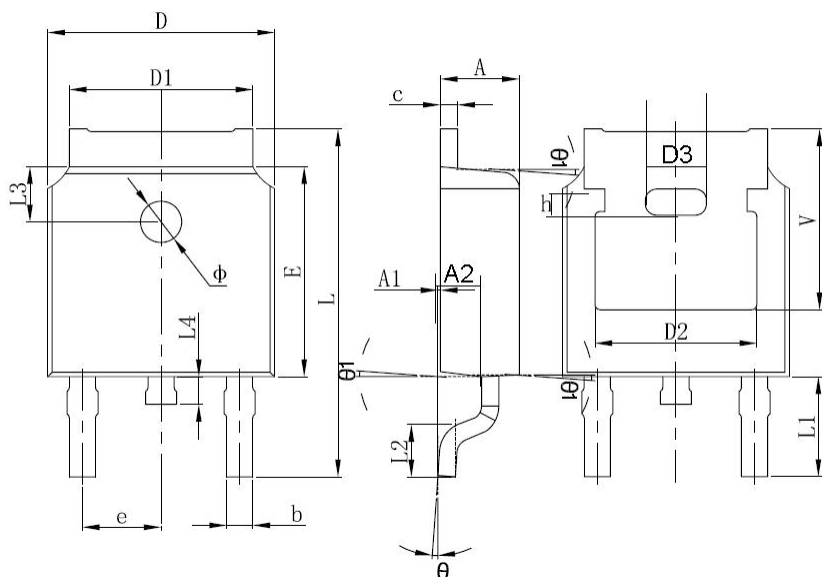

Fig.3-Typical Instantaneous Forward Voltage Characteristics

Mechanical Dimensions DPAK

SYMBOL	Millimeters		Inches	
	Min.	Max.	Min.	Max.
A	2.20	2.40	0.087	0.094
A1	0.00	0.127	0.000	0.005
b	0.66	0.86	0.026	0.034
c	0.46	0.60	0.018	0.024
D	6.50	6.70	0.256	0.264
D1	5.13	5.46	0.202	0.215
D2	4.83 REF.		0.190 REF.	
E	6.00	6.20	0.236	0.244
e	2.186	2.386	0.086	0.094
L	9.70	10.40	0.381	0.409
L1	2.90 REF.		0.144 REF.	
L2	1.40	1.70	0.055	0.067
L3	1.60 REF.		0.063 REF.	
L4	0.60	1.00	0.024	0.039
Φ	1.10	1.30	0.043	0.051
θ	0°	8°	0°	8°
V	5.35 REF.		0.211 REF.	

Ordering Information

Device	Package	Shipping
MBRD2060	DPAK (Pb-Free)	2500pcs / reel
MBRD2060TR	DPAK (Pb-Free)	2500pcs / reel

For information on tape and reel specifications, including part orientation and tape sizes, please refer to our tape and reel packaging specification.

Marking Diagram

Where XXXXX is YYWWL

MBRD2060 = Part Name
 SSG = SSG
 YY = Year
 WW = Week
 L = Lot Number

Cautions: Molding resin
 Epoxy resin UL:94V-0

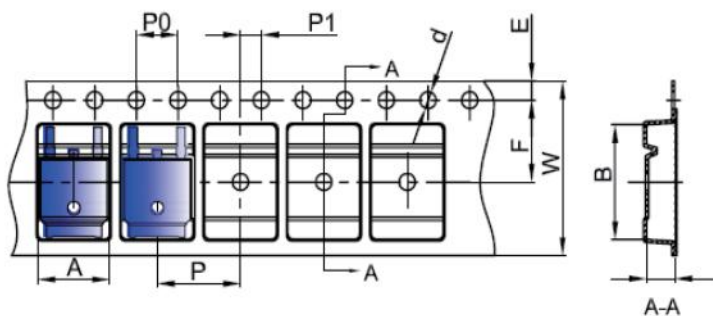
Carrier Tape & Reel Specification DPAK

SYMBOL	Millimeters	
	Min.	Max.
A	6.80	7.00
B	10.40	10.60
C	2.60	2.80
d	Φ1.45	Φ1.65
E	1.65	1.85
F	7.40	7.60
P0	3.90	4.10
P	7.90	8.10
P1	1.90	2.10
W	15.90	16.30

DISCLAIMER:

- 1- The information given herein, including the specifications and dimensions, is subject to change without prior notice to improve product characteristics. Before ordering, purchasers are advised to contact the SMC Diode Solutions sales department for the latest version of the datasheet(s).
- 2- In cases where extremely high reliability is required (such as use in nuclear power control, aerospace and aviation, traffic equipment, medical equipment, and safety equipment), safety should be ensured by using semiconductor devices that feature assured safety or by means of users' fail-safe precautions or other arrangement.
- 3- In no event shall SMC Diode Solutions be liable for any damages that may result from an accident or any other cause during operation of the user's units according to the datasheet(s). SMC Diode Solution assumes no responsibility for any intellectual property claims or any other problems that may result from applications of information, products or circuits described in the datasheets.
- 4- In no event shall SMC Diode Solutions be liable for any failure in a semiconductor device or any secondary damage resulting from use at a value exceeding the absolute maximum rating.
- 5- No license is granted by the datasheet(s) under any patents or other rights of any third party or SMC Diode Solutions.
- 6- The datasheet(s) may not be reproduced or duplicated, in any form, in whole or part, without the expressed written permission of SMC Diode Solutions.
- 7- The products (technologies) described in the datasheet(s) are not to be provided to any party whose purpose in their application will hinder maintenance of international peace and safety nor are they to be applied to that purpose by their direct purchasers or any third party. When exporting these products (technologies), the necessary procedures are to be taken in accordance with related laws and regulations..